

# Saramonic

Sound.Remarkable. 🎧

Wired/Wireless Dual-Function Microphone

有线/无线双功能麦克风

## SR-MV2000W

User Manual  
用户手册



## Product Structure

TX

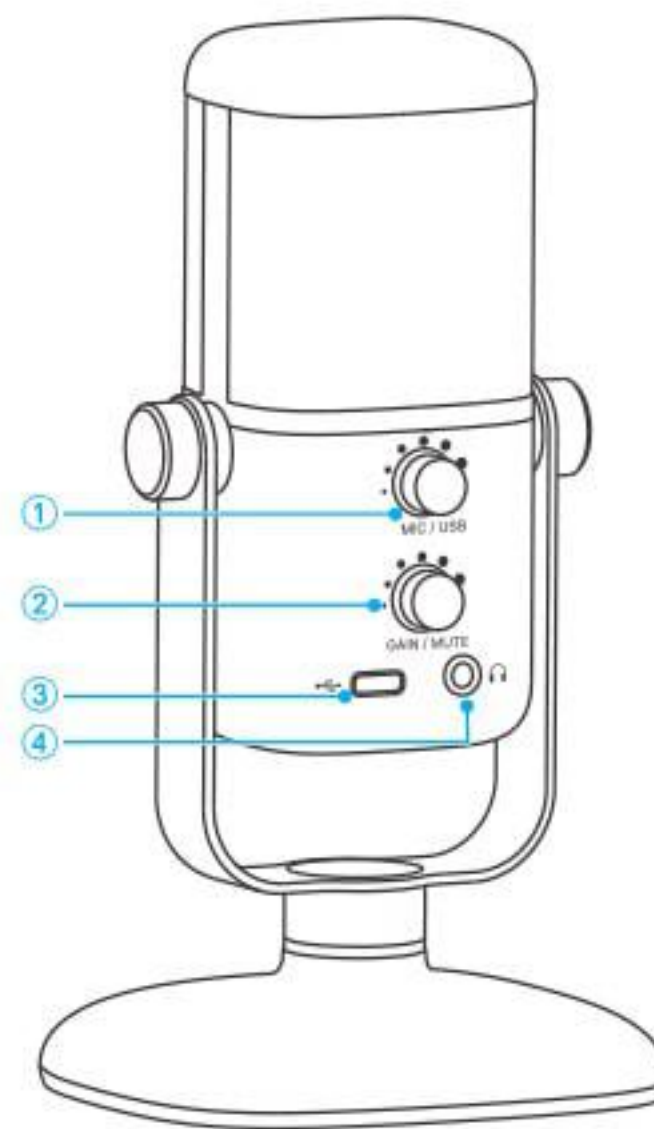

- ① Headphone volume control
- ② Gain/mute control
- ③ Type-C port
- ④ 3.5mm headphone jack

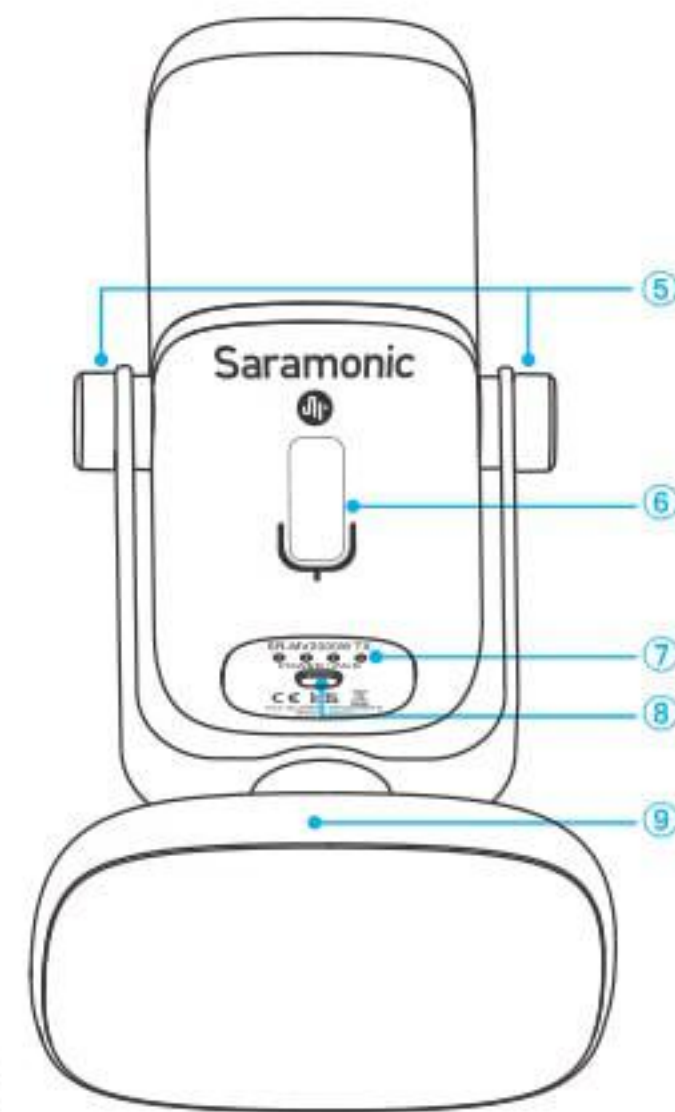

- ⑤ Locking knob
- ⑥ Smart LED indicator
- ⑦ Battery level indicator
- ⑧ Power/pair button
- ⑨ Mic stand

RX

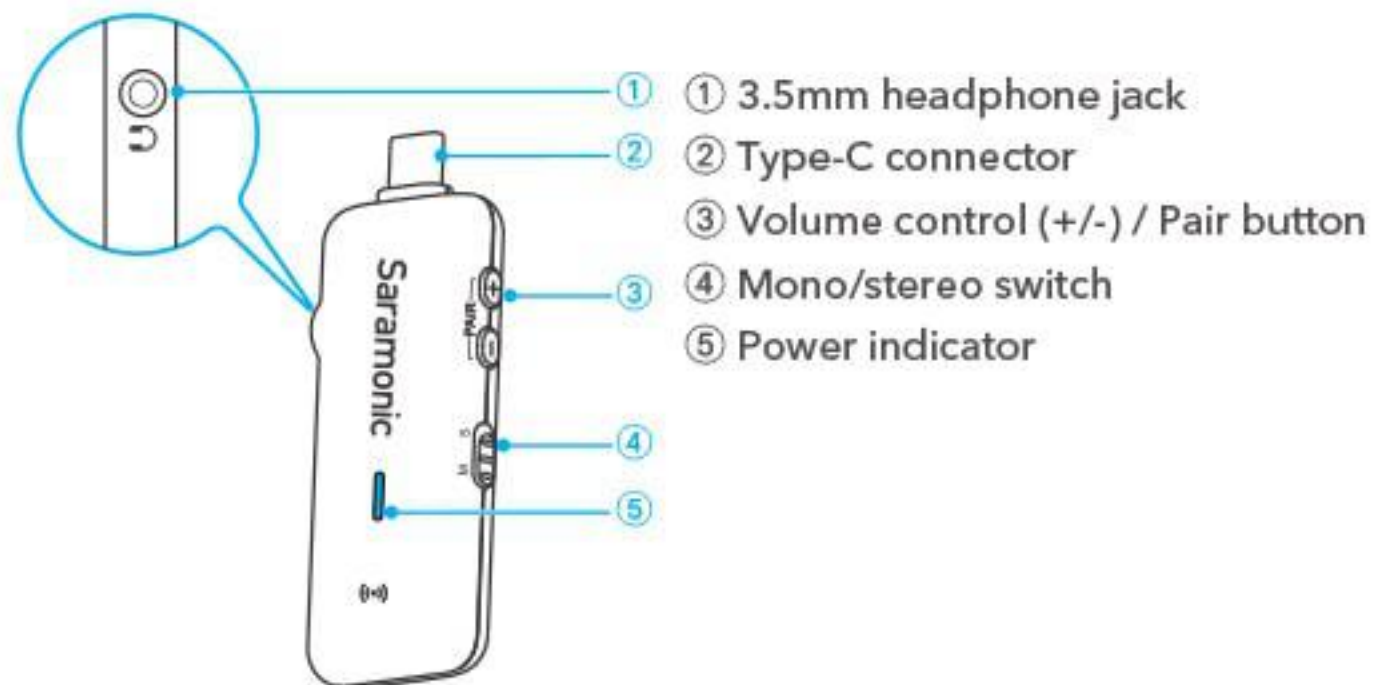

## Accessories

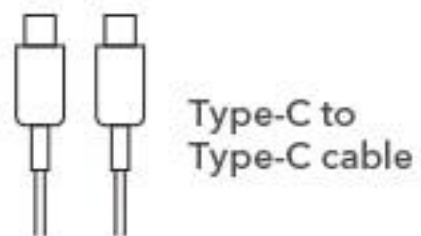
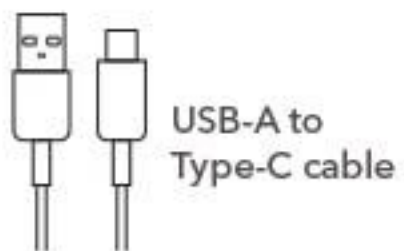
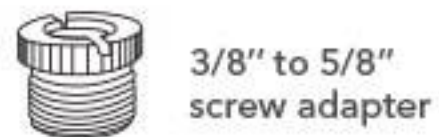

## Functions

### 1. Magnetic Base

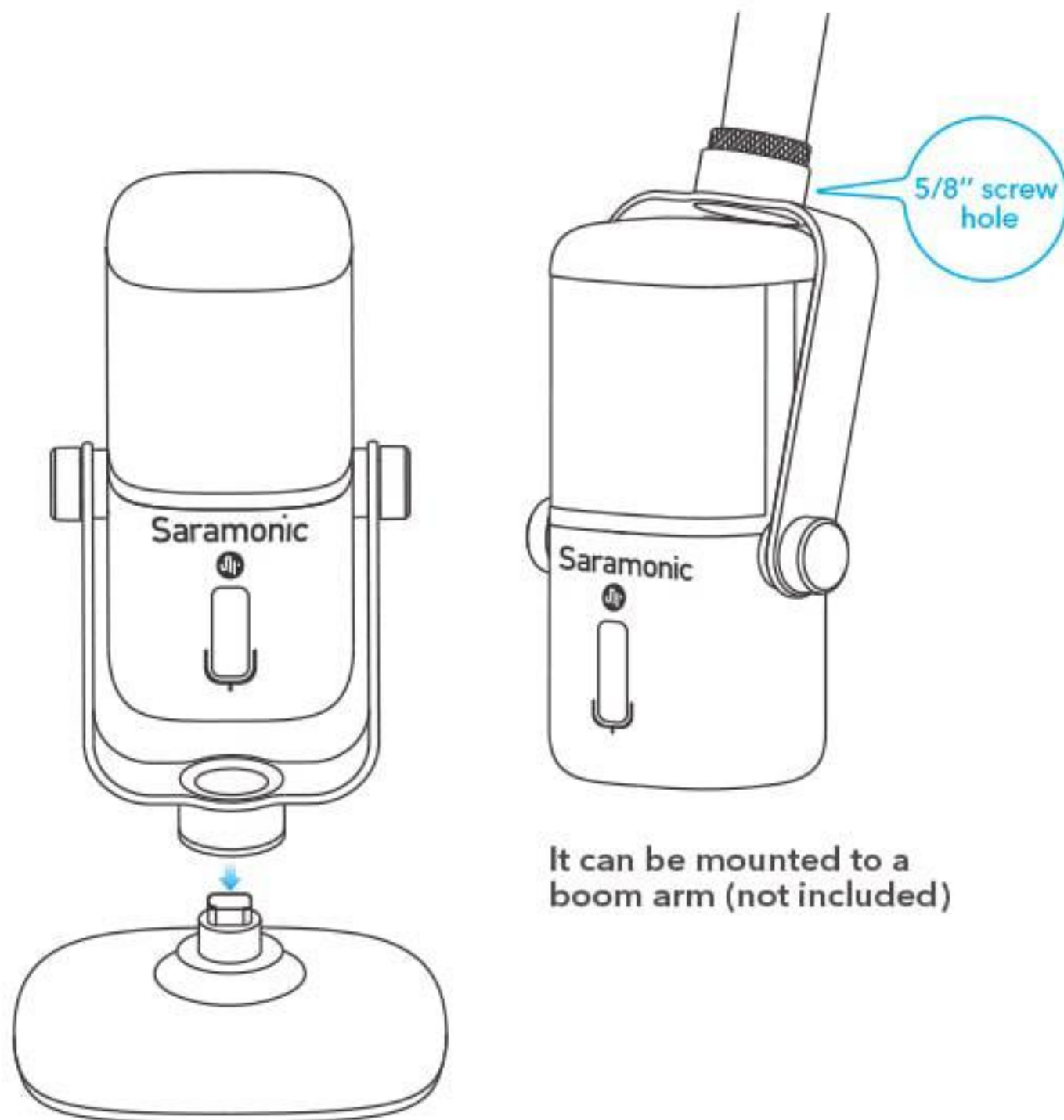

## 2. Angle Adjustment

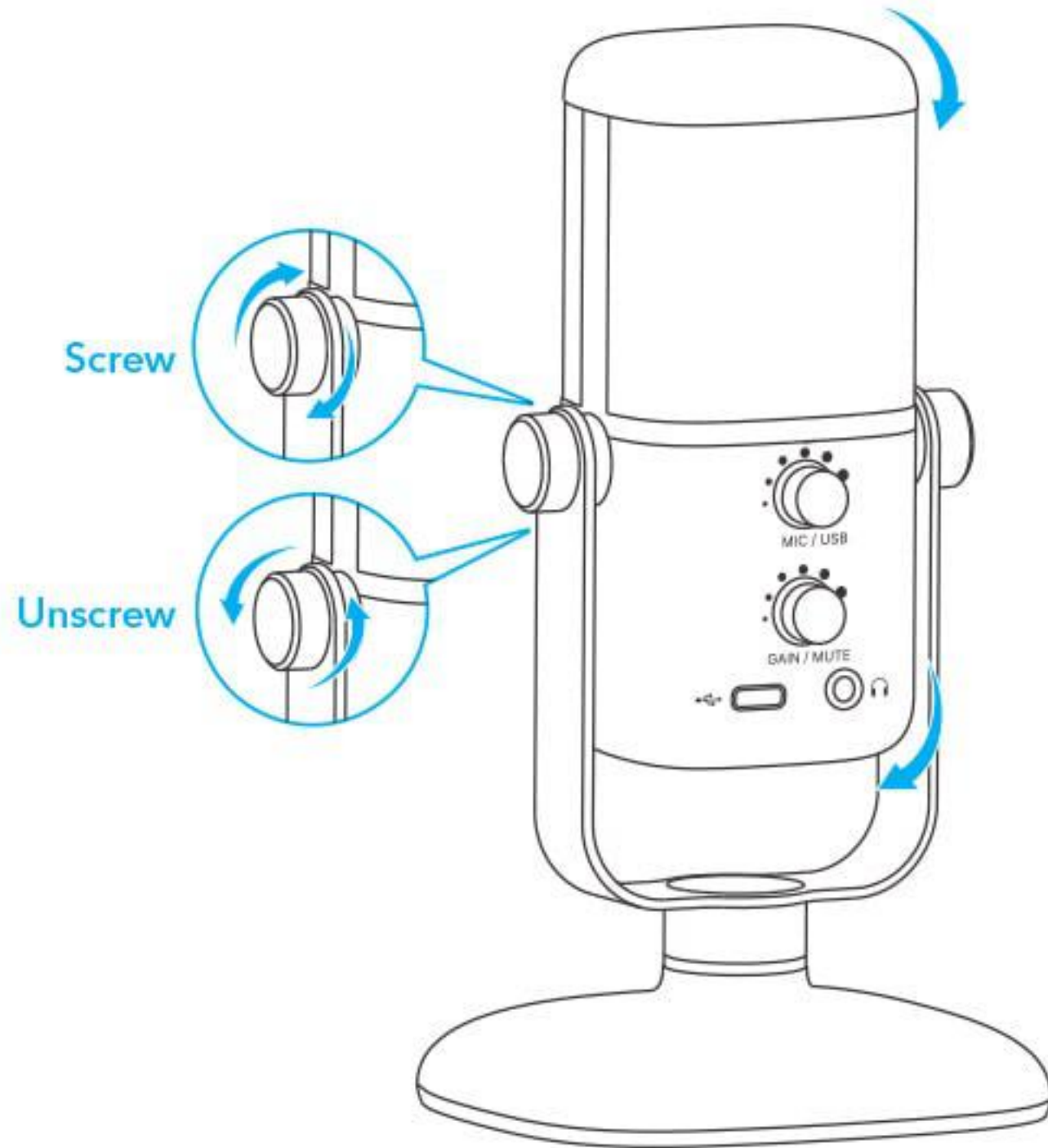

## Battery Charging

Indicator	Status
☉ - ☉ - ☉ - ☉	Charging (breathing white light)
○ ○ ○ ○	Full charged
○ ○ ○ ●	Current battery level (75% power)
○ ● ● ●	Low battery (25% power)

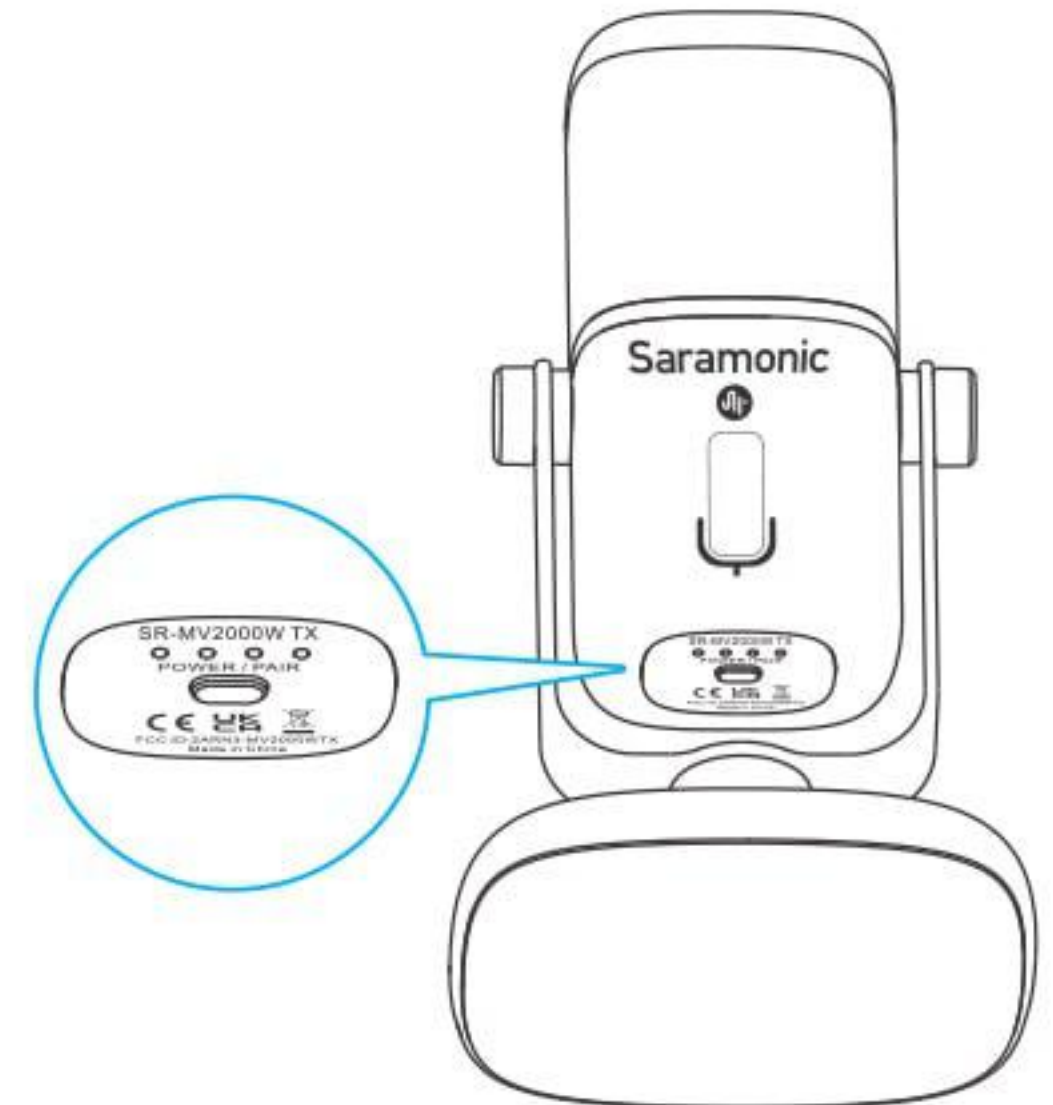

# Operation Guide

## A - Wired Operation

### 1. Connect the microphone to your smartphone/computer

Devices	Smartphone	Computer
Connection	Type-C to Type-C cable; Type-C to Lightning cable (not included)	USB-A to Type-C cable
System Requirements	Android/iOS devices	Windows 7/10 Mac OS 10.12 or later

#### Note:

1. SR-MV2000W is also compatible with iOS devices. The Type-C to Lightning adapter cable is not included. Please purchase it separately if needed.

2. For optimum sound, please press and hold the volume control and gain control knobs simultaneously to restore factory setting. The indicator will turn red and blinks three times.

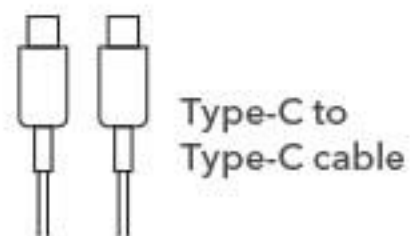

Type-C to Type-C cable



USB-A to Type-C cable

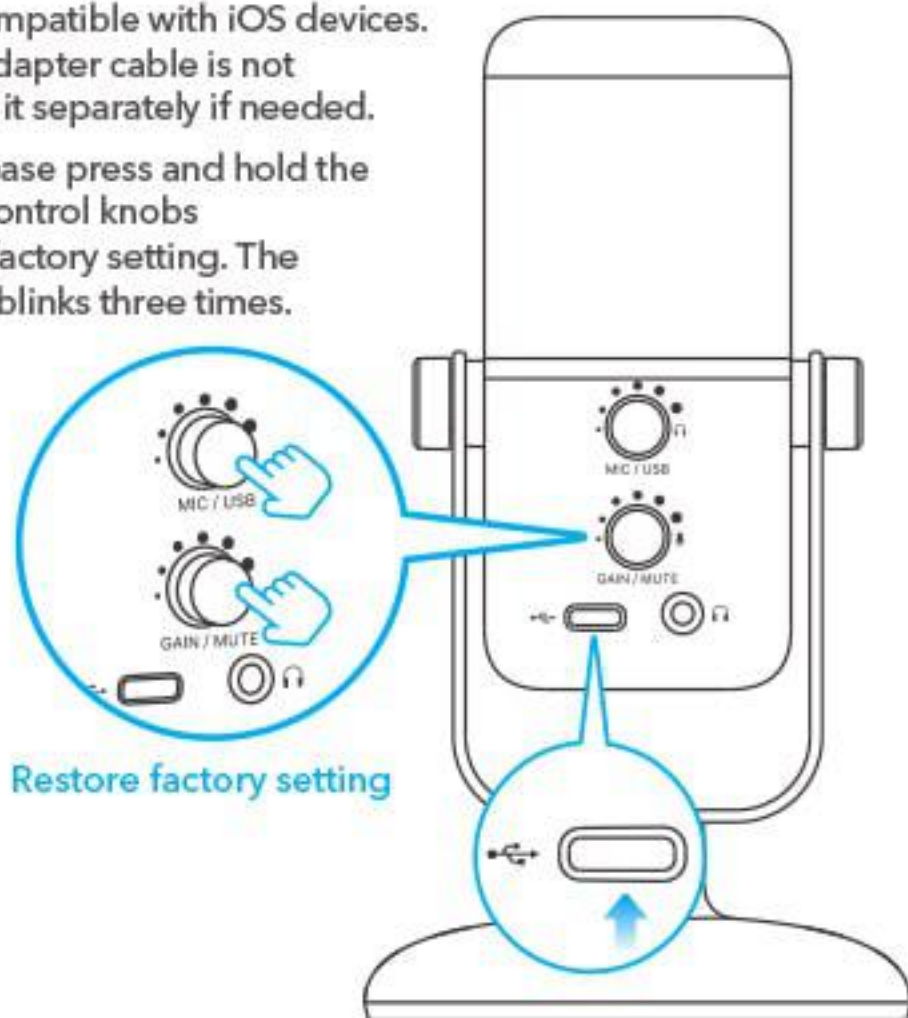

### 2. Adjust the knobs according to your needs

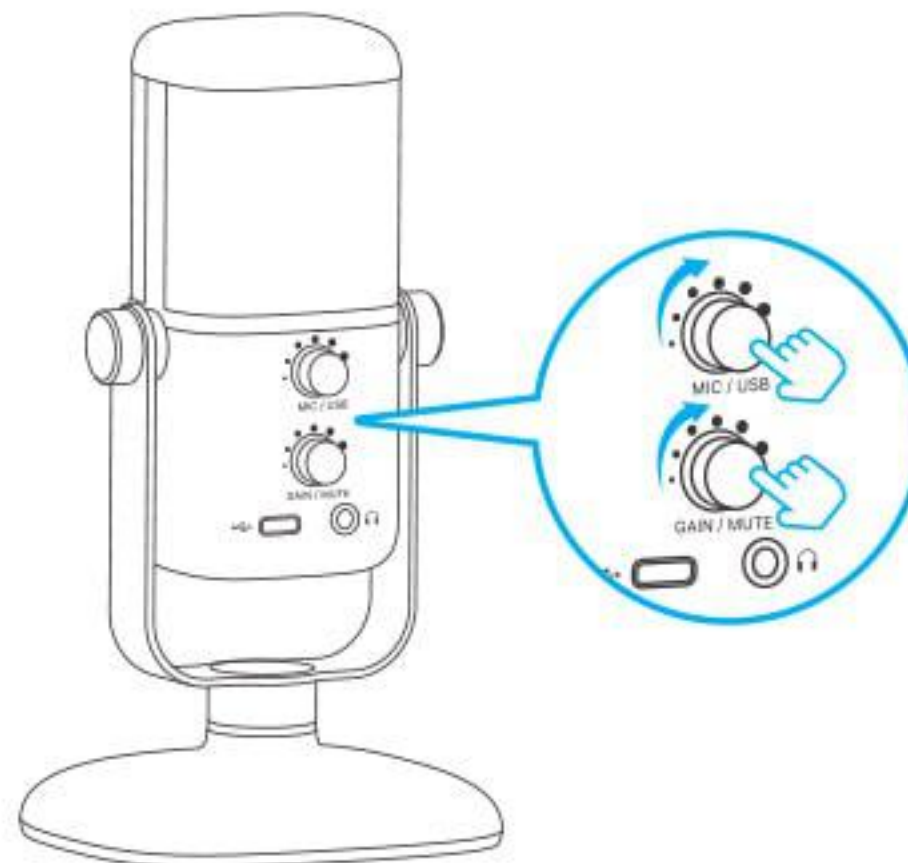

	Direct/Playback Monitoring		Gain/Mute Control	
Control Button				
Smart LED Indicator Color	MIC (Direct monitoring)	USB (Playback monitoring)	GAIN	MUTE
Operating	Press the button to switch between direct and playback monitoring; Turn the knob to adjust the headphone volume.		Press the button to mute/unmute the microphone; Turn the knob to adjust gains for microphone input level.	

## B - Wireless Operation

### 1. Turn on the transmitter

Note: When using the wired function, short press the power button to enable the wireless function simultaneously.

Press and hold the power button

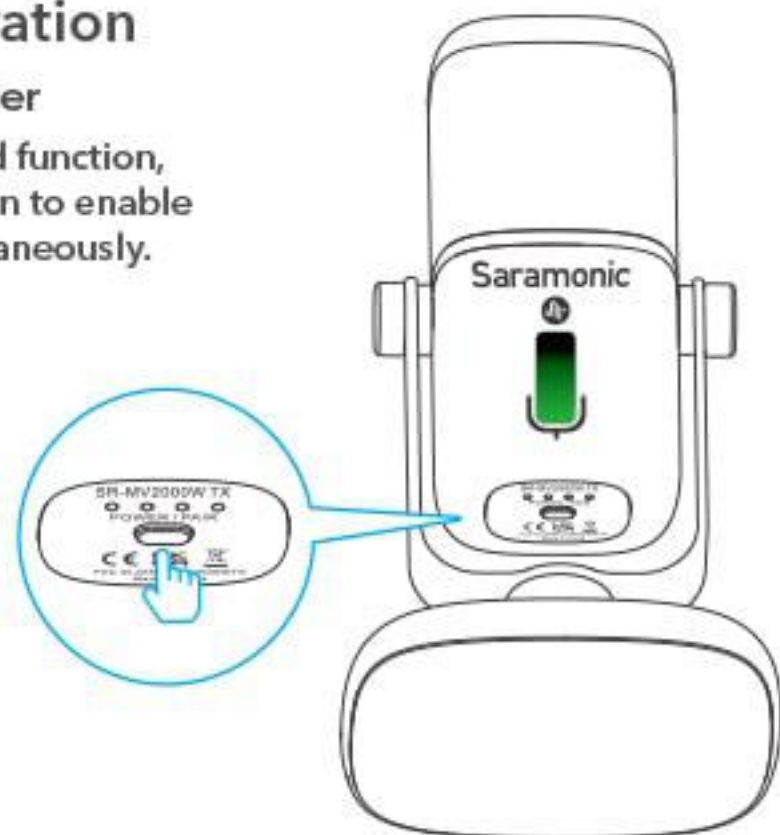

### 3. TX & RX Pairing

#### TX

Status	Indicator light colour
Unpaired	green light flashes in cycle
Pairing	green light flashes rapidly
Paired Successfully	solid green light

Double-click the pair button to enter pairing mode

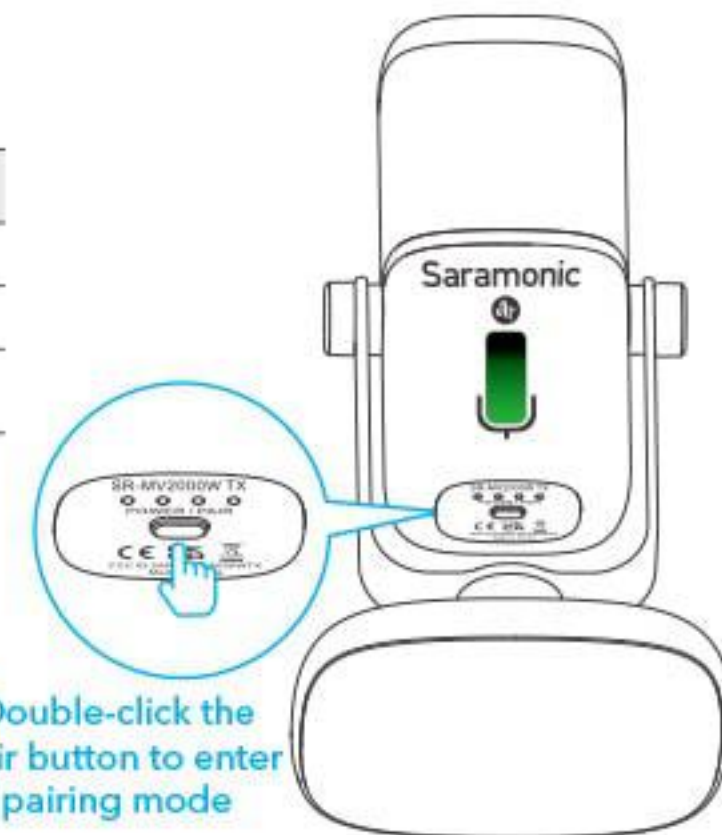

### 2. Connect the receiver to an external device

#### ①. Connect to a Type-C device



#### ②. Connect to a USB-A device



#### RX

Connect a headphone for audio monitoring

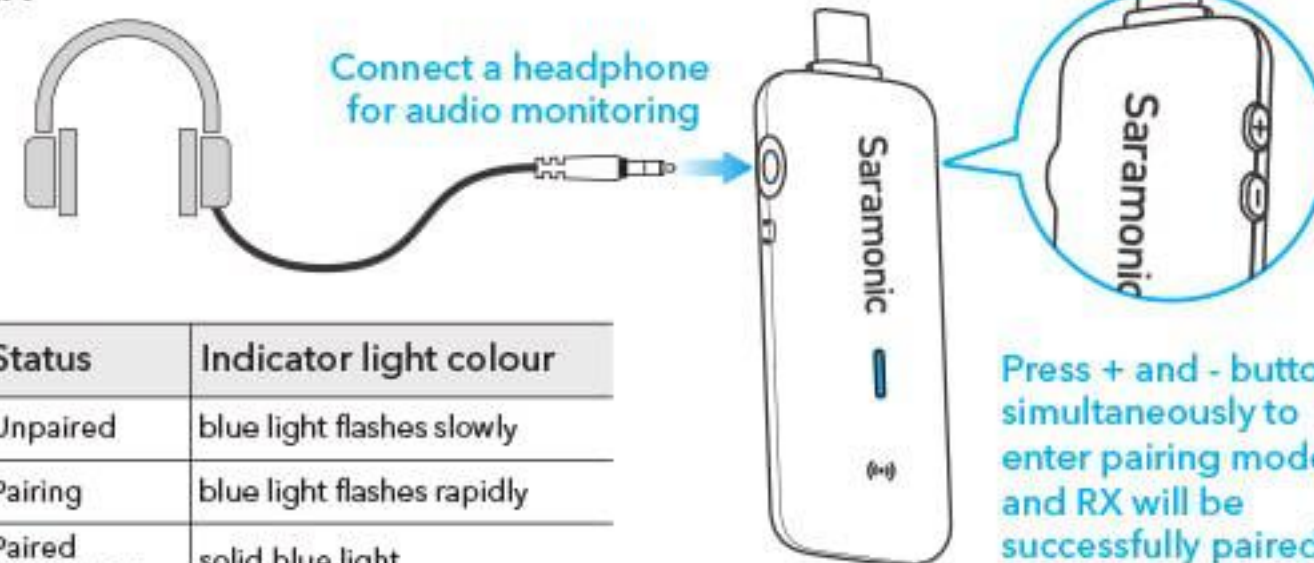

Press + and - buttons simultaneously to enter pairing mode, TX and RX will be successfully paired within 10s.

Status	Indicator light colour
Unpaired	blue light flashes slowly
Pairing	blue light flashes rapidly
Paired Successfully	solid blue light

Note: If you ever need to use two USB mic in one device, you can simply add a second SR-MV2000W wireless transmitter (sold separately) and make it a 2-person wireless microphone. To add a second SR-MV2000W transmitter, please repeat the above pairing operation.

# Specifications

## Wired Operation

Mic Capsule	14mm Electret Condenser Capsule
Polar Pattern	Cardioid
Frequency Response	20Hz-20kHz
Sensitivity	-36dB (0dB=1V/Pa, 1kHz 1Pa)
Signal-to-Noise Ratio	80dB
Maximum SPL	120dB
Sampling Rate	48kHz
Bit Rate	16bit/24bit
Mic Gain	0~54dB
Working Voltage	5V 110mA
Audio Output Connector	3.5mm Headphone Jack, Type-C Port
Operating Temperature	0°C to 50°C
Storage Temperature	-20°C to +55°C

## Wireless Operation

Mic Capsule	14mm Electret Condenser Capsule
Polar Pattern	Cardioid
Frequency Response	35Hz-18kHz
Sensitivity	-36dB (0dB=1V/Pa, 1kHz 1Pa)
Signal-to-Noise Ratio	80dB

Maximum SPL	120dB
Transmission Type	2.4GHz
Modulation	GFSK
Antenna	Dipole Antenna
Operating Range	60m (Outdoors without obstacles)
RF Output Power	<10mW
Distortion	<0.05%
Battery Life	6 hours
Charging Time	1.5 hours
Battery Capacity	850mAh
Dimensions	TX: 165×78.6×90mm RX: 71.6×27.1×10.55mm
Weight	TX: 359g RX: 12.5g

## Packing List

- SR-MV2000W Microphone×1
- Wireless Receiver×1
- Type-C Female to USB-A Male Adapter×1
- 3/8'' to 5/8'' Screw Adapter×1
- 6.6'(2m) USB-A to Type-C Cable×1
- 6.6'(2m) Type-C to Type-C Cable×1

## Polar Pattern

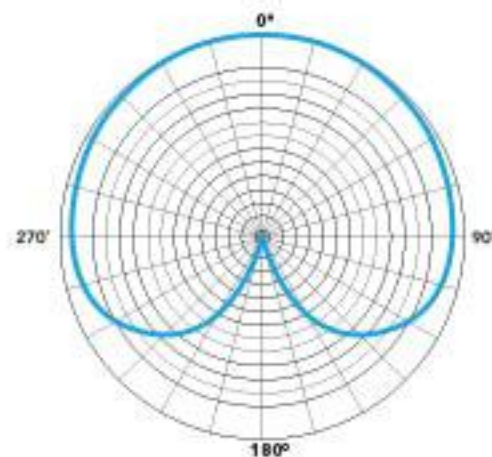

## Frequency Response

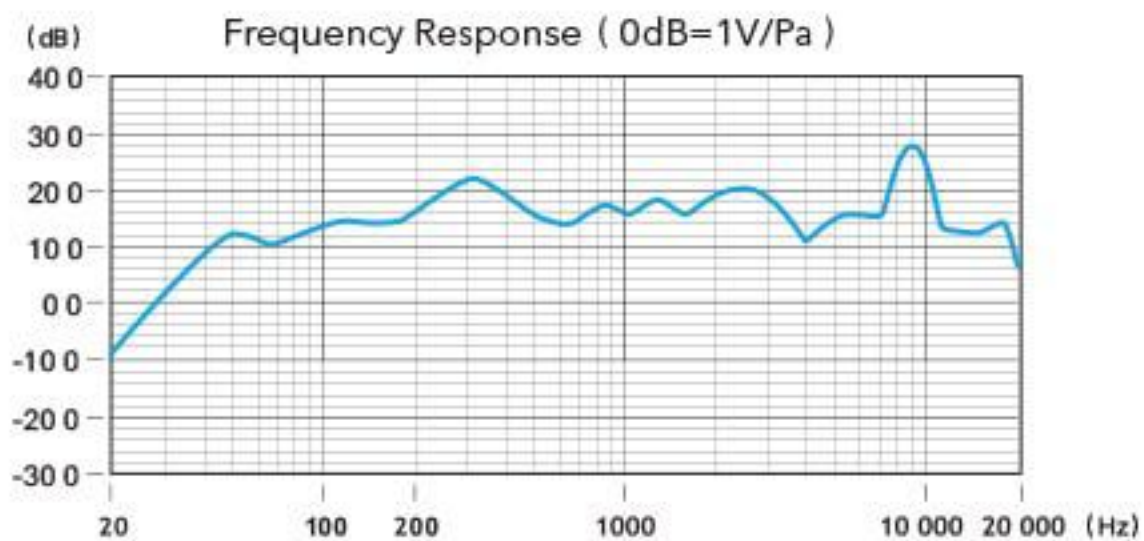

## 产品结构

TX

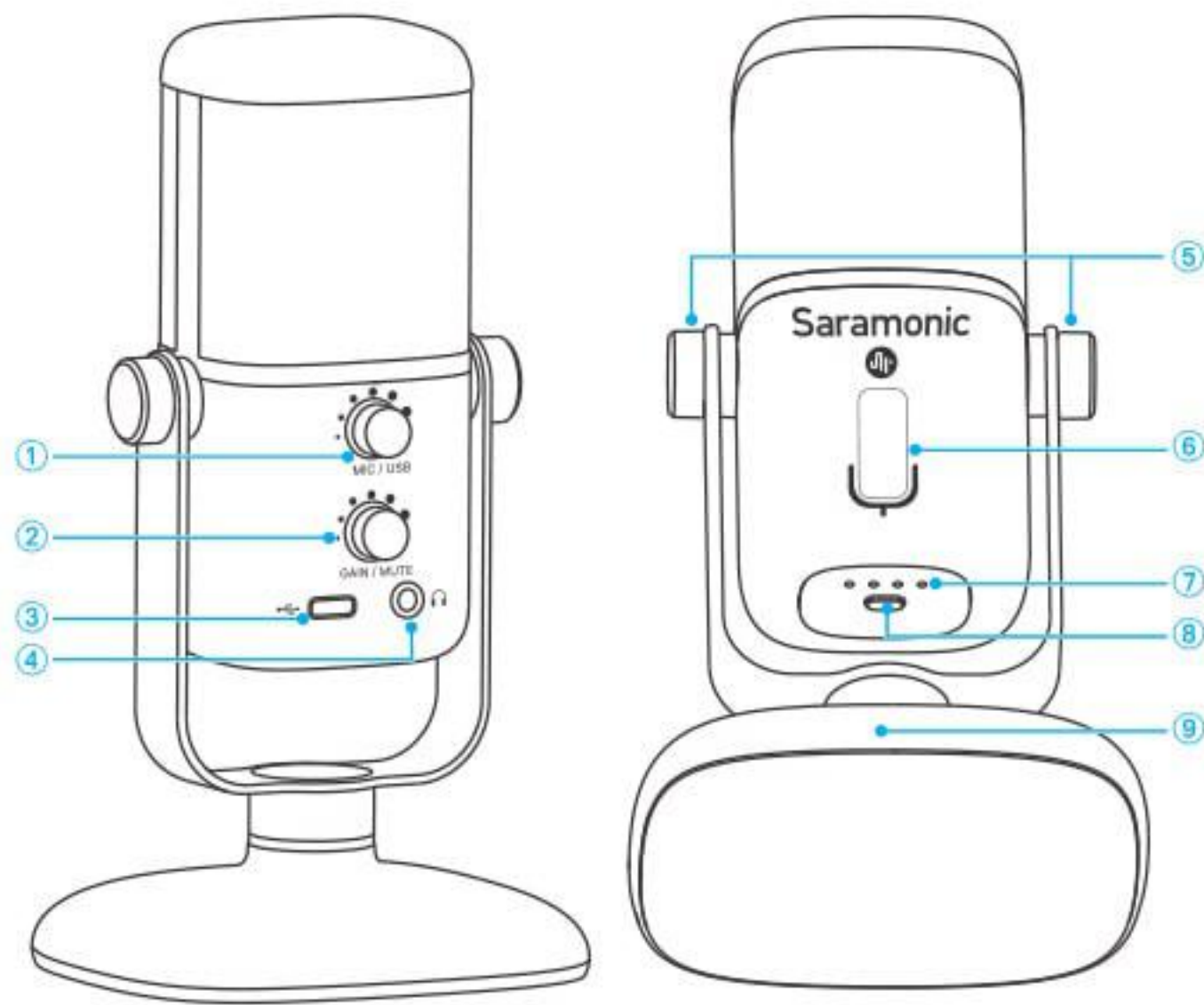

- ① 耳机音量调节旋钮
- ② 增益/静音控制旋钮
- ③ Type-C接口
- ④ 3.5mm耳机插孔

- ⑤ 锁紧旋钮
- ⑥ 智能LED指示灯
- ⑦ 电量指示灯
- ⑧ 电源/配对键
- ⑨ 麦克风桌面支架

RX

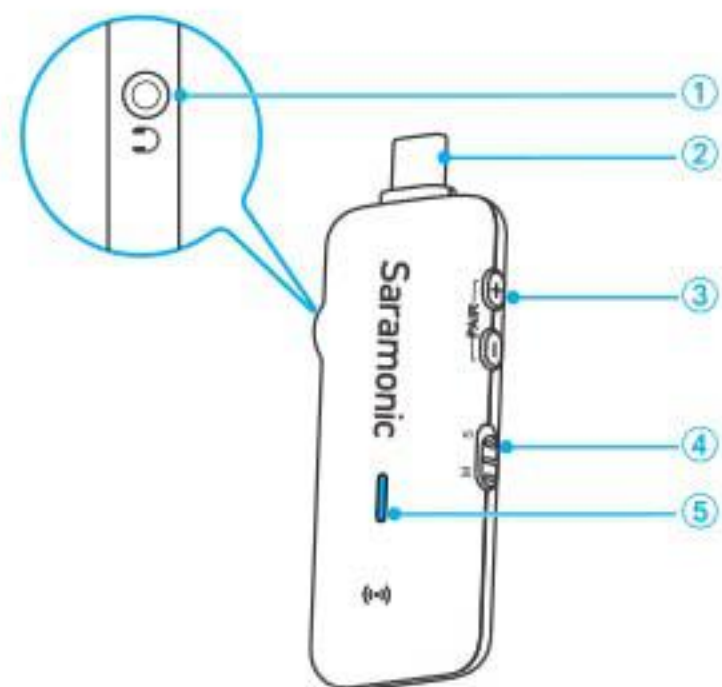

- ① 3.5mm耳机插孔
- ② Type-C接口
- ③ 耳机音量调节(+/-) / 配对键
- ④ 单声道/立体声切换键
- ⑤ 电源指示灯

## 配件

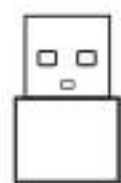

Type-C母头转  
USB-A转接头



3/8"转5/8"  
支架转换螺母

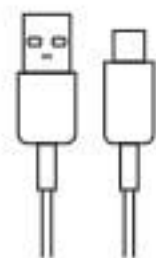

USB-A转  
Type-C数据线

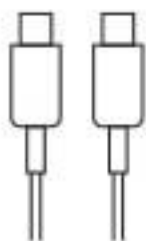

Type-C转  
Type-C数据线

## 功能

### 1. 磁吸底座

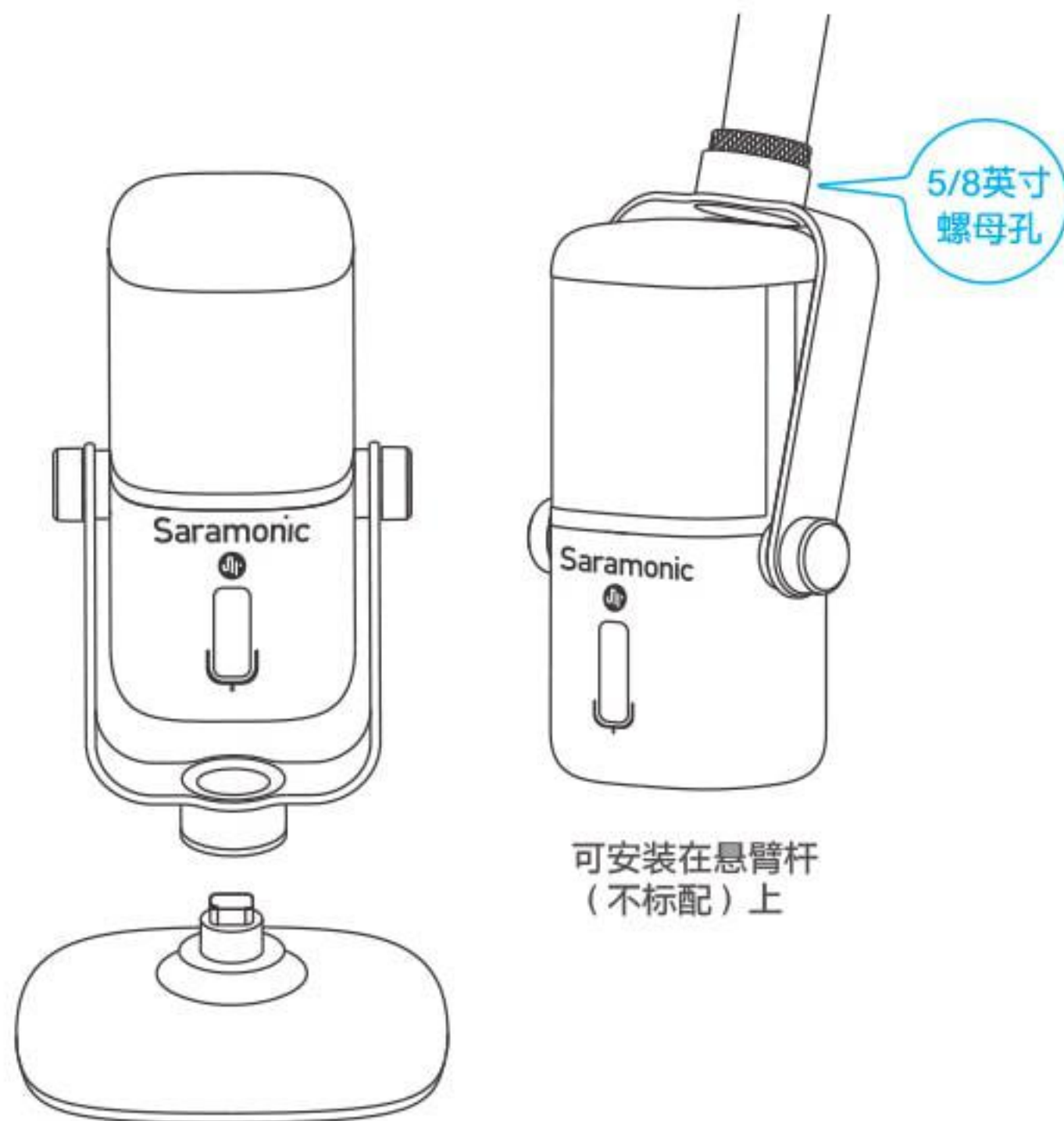

可安装在悬臂杆  
(不标配)上



## 2. 麦克风角度调节

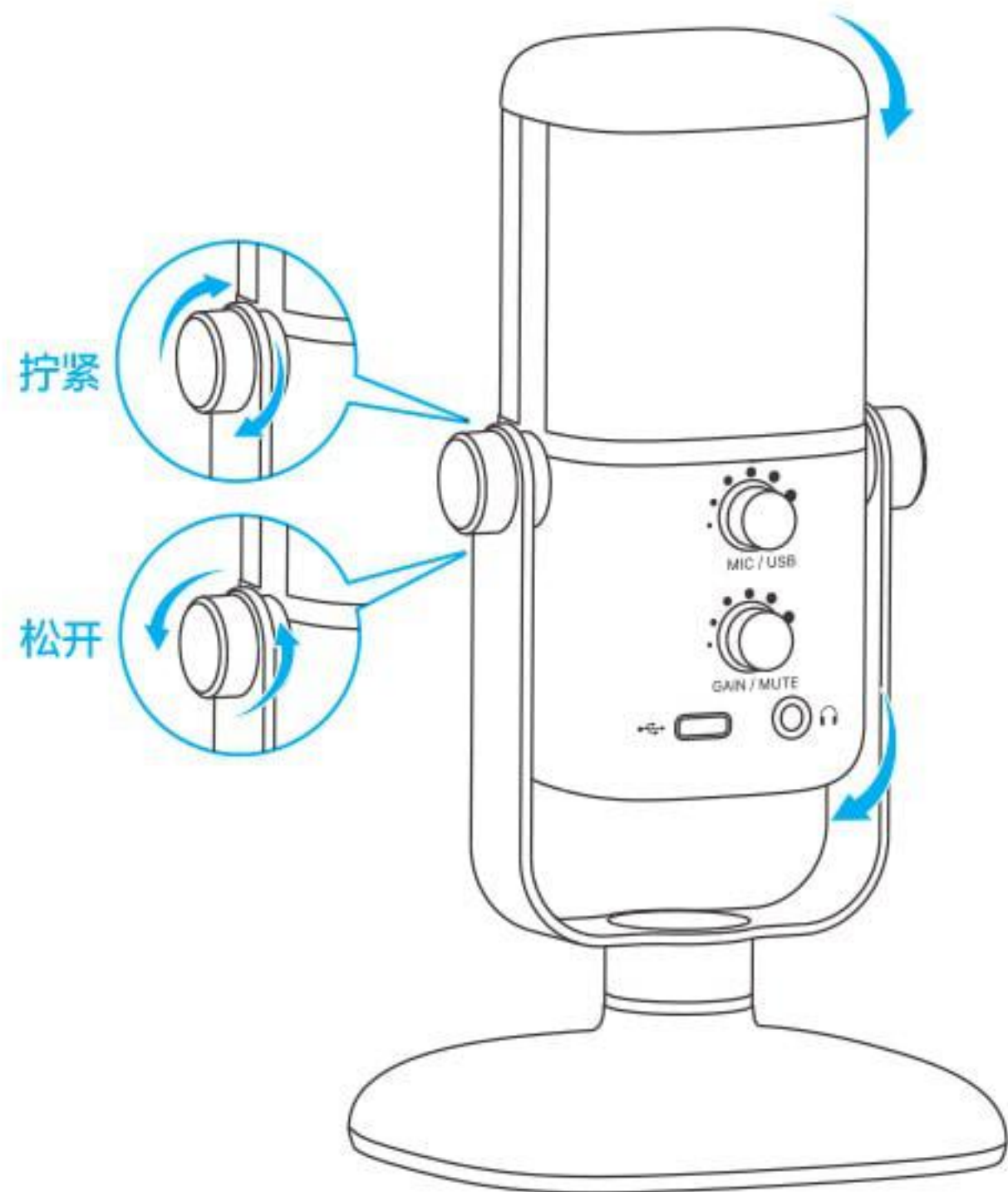

## 电池充电

指示灯	状态
⦿ - ⦿ - ⦿ - ⦿	充电中 (呼吸灯闪烁状态)
○ ○ ○ ○	充满电
○ ○ ○ ●	当前电量 (仅为示意: 电量75%)
○ ● ● ●	低电量 (电量25%)

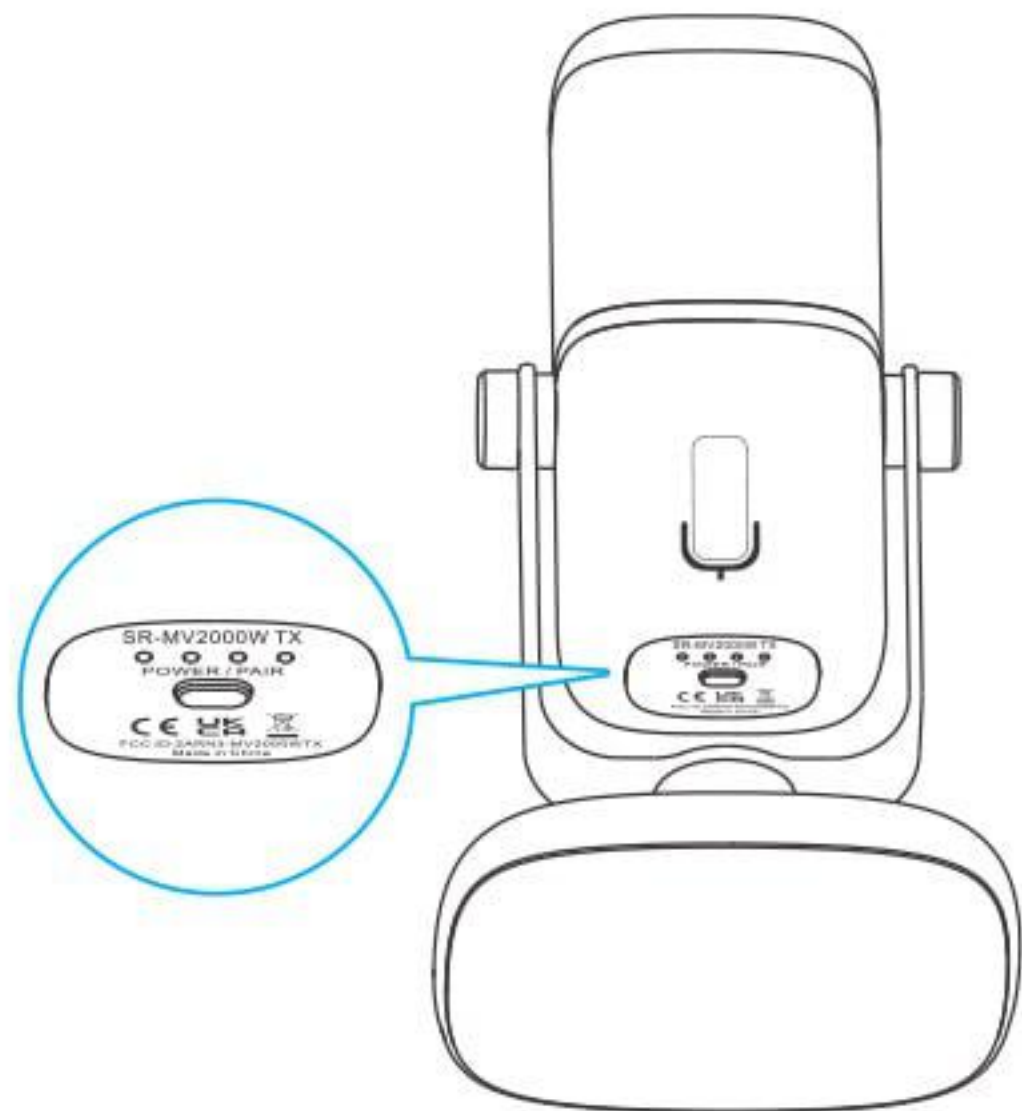

# 操作指南

## A - 有线操作

### 1. 将麦克风连接至手机/电脑

设备	手机	电脑
连接	Type-C转Type-C数据线, Type-C转Lightning转接线 (不标配)	USB-A转Type-C数据线
系统支持	安卓/iOS设备	Windows 7/10 Mac OS 10.12以上

注意:

1. SR-MV2000W 也与 iOS 设备兼容。包装内不含 Type-C转Lightning转接线, 如需使用请另外购买。
2. 为获得最佳声音效果, 请同时长按音量调节和增益调节旋钮以恢复出厂 (最佳) 设置, 指示灯变为红灯并闪烁三下。

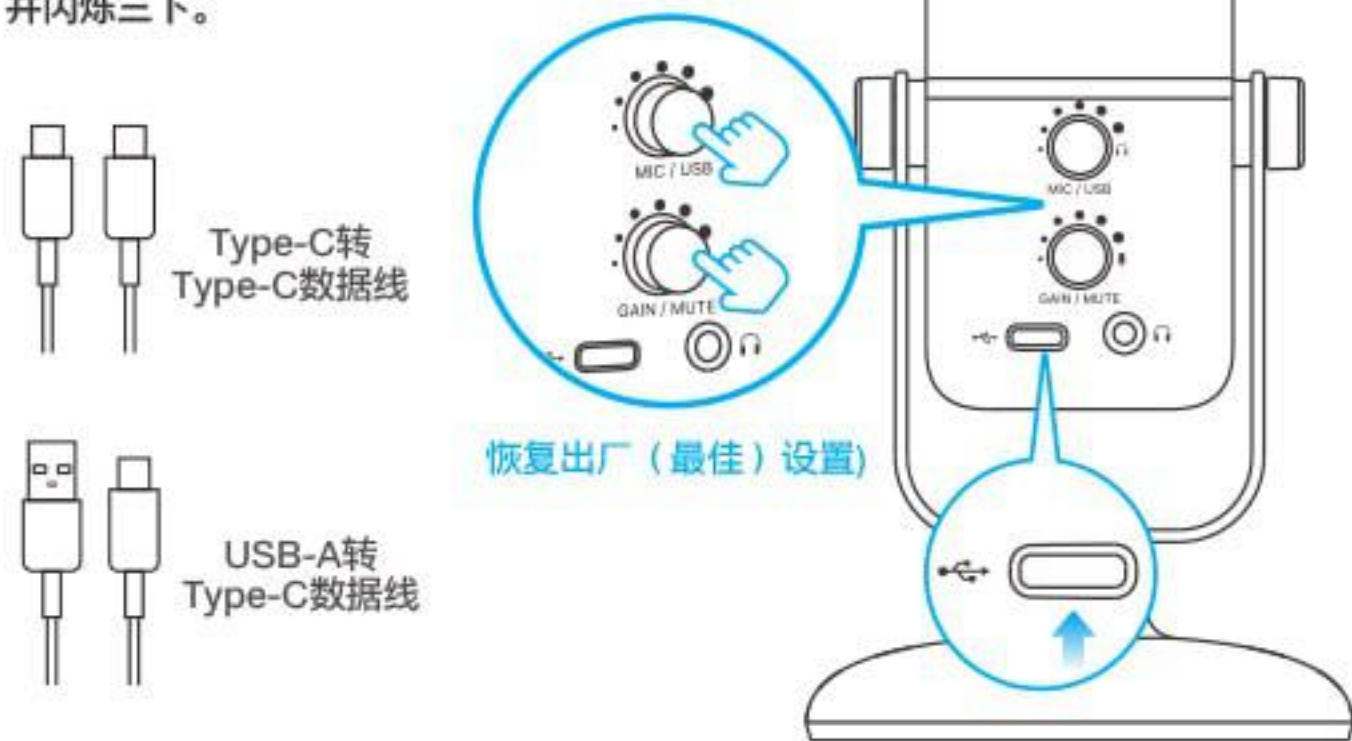

### 2. 根据录制需要调节旋钮

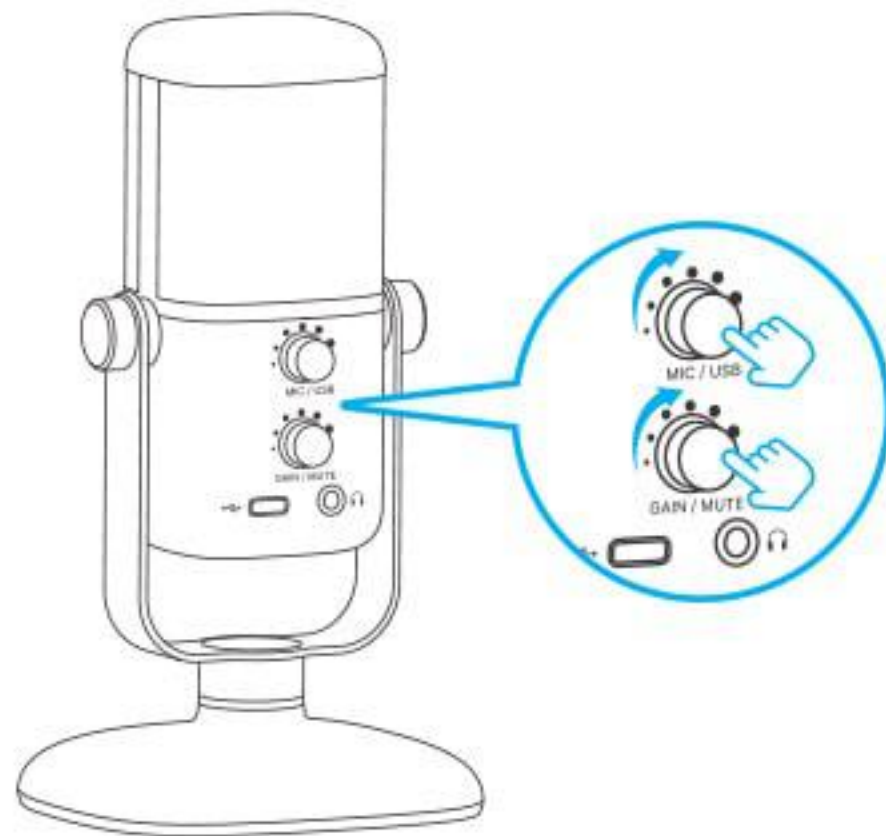

	实时监听/回放监听	增益/静音	
按键			
智能LED指示灯颜色	MIC (实时监听)     USB (回放监听)	GAIN (麦克风实时音量)	MUTE (静音)
操作	短按旋钮切换实时监听模式和回放监听模式 转动旋钮调节耳机监听音量	短按旋钮进入/取消静音状态 转动旋钮调节麦克风增益	

## B - 无线操作

### 1. 发射器开机

注意：使用有线功能时，  
短按电源键可同时开启无线功能。

长按电源键  
(启动发射器)

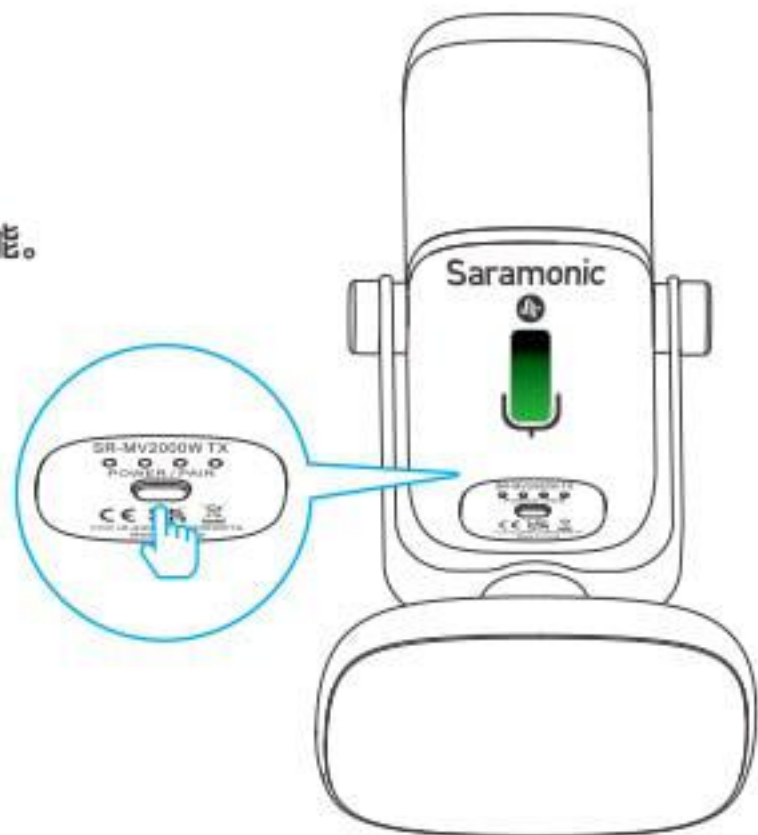

### 2. 接收器接入外部设备

#### ①. 连接Type-C设备



#### ②. 连接USB-A设备

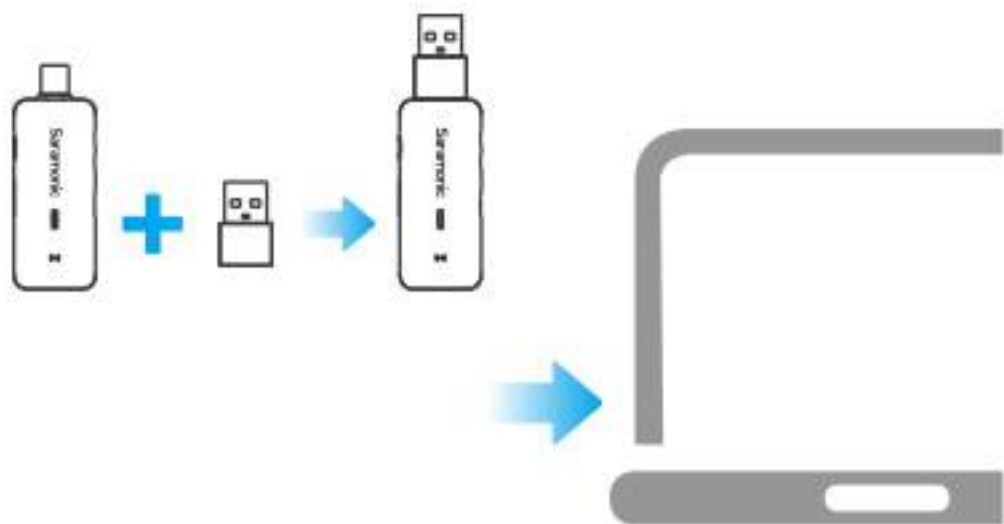

### 3. 发射器与接收器配对

TX

状态	未联机	对码中	联机成功
指示灯颜色	绿灯巡回跳动	绿灯快速双闪	绿灯常亮

双击配对键  
进入配对模式



RX

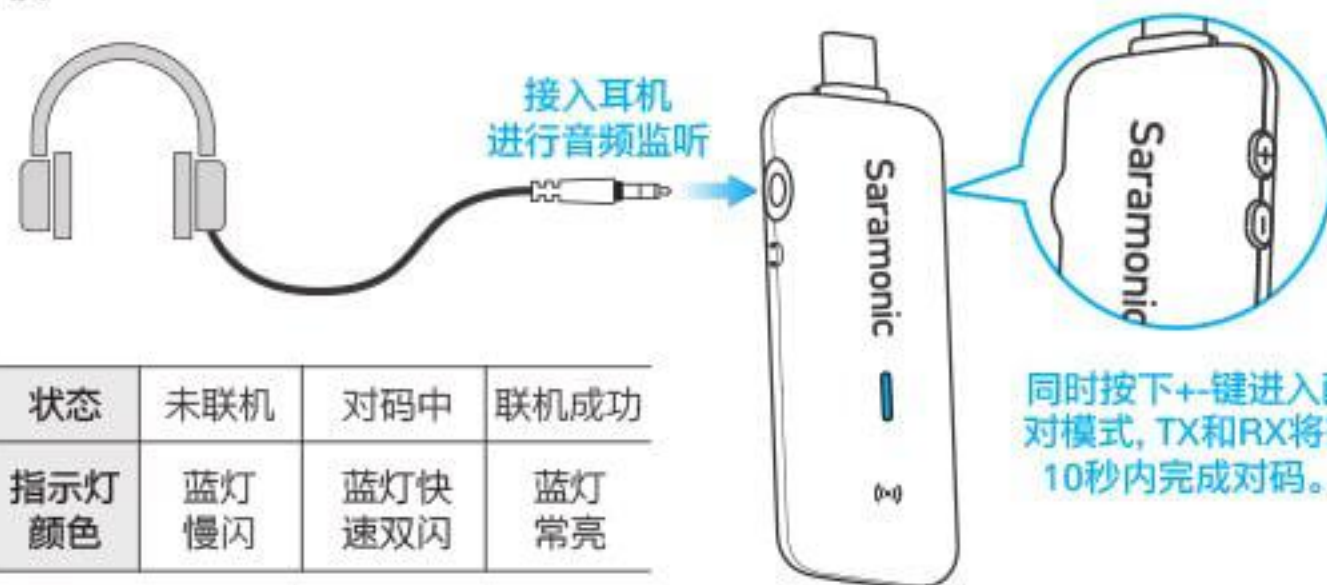

状态	未联机	对码中	联机成功
指示灯颜色	蓝灯慢闪	蓝灯快速双闪	蓝灯常亮

注意：接收器支持一拖二使用，可同时连接两台SR-MV2000W无线发射器（第二台SR-MV2000W发射器需另购）。如需连接第二台SR-MV2000W发射器，请重复上述配对操作。

## 参数

### 有线操作

拾音器	14mm驻极体电容咪头
极性模式	心形
频率响应	20Hz-20kHz
灵敏度	-36dB (0dB=1V/Pa, 1kHz 1Pa)
信噪比	80dB
最大声压级	120dB
采样率	48kHz
比特率	16bit/24bit
麦克风增益	0~54dB
工作电压	5V 110mA
音频输出接口	3.5mm耳机插孔, Type-C接口
工作温度	0° C~50° C
储存温度	-20° C~+55° C

### 无线操作

拾音器	14mm驻极体电容咪头
极性模式	心形
频率响应	35Hz-18kHz
灵敏度	-36dB (0dB=1V/Pa, 1kHz 1Pa)
信噪比	80dB

最大声压级	120dB
传输方式	2.4GHz
调制方式	高斯频移键控
天线	偶极天线
工作范围	60米 (户外无障碍)
射频输出功率	<10mW
失真	<0.05%
续航	6小时
充电时间	1.5小时
电池容量	850mAh
尺寸	TX: 165 × 78.6 × 90mm RX: 71.6 × 27.1 × 10.55mm
重量	TX: 359g RX: 12.5g

## 包装清单

- SR-MV2000W麦克风 × 1
- 无线接收器 × 1
- Type-C母头转USB-A 转接头 × 1
- 3/8" 转5/8"转换螺母 × 1
- 2米USB-A转Type-C数据线 × 1
- 2米Type-C转Type-C数据线 × 1

## 极性模式

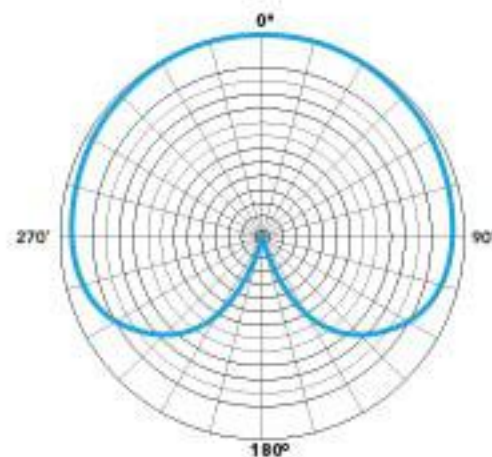

## 频率响应

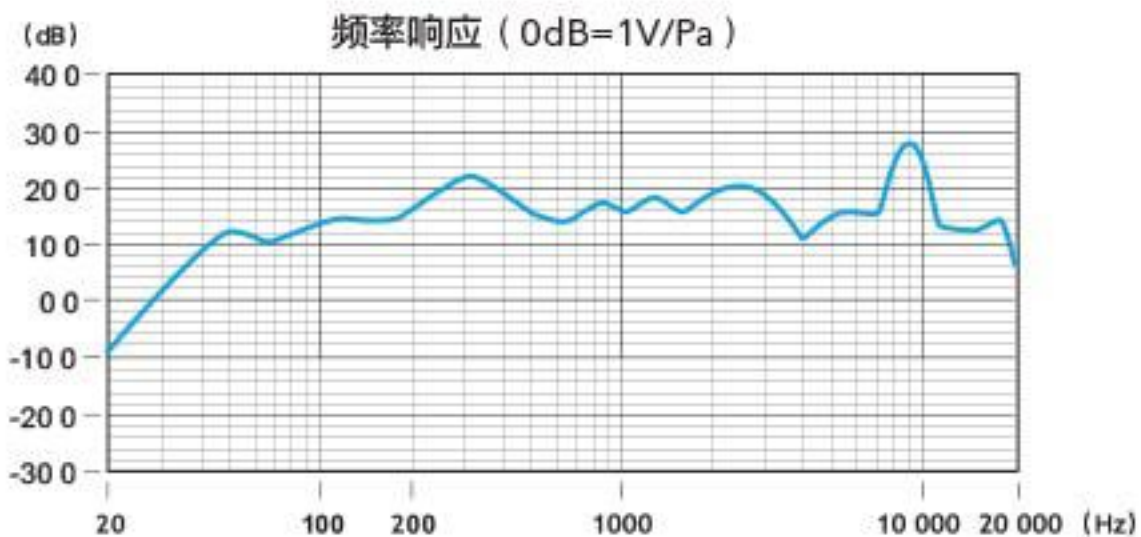

For better recording experience, the application **SmartRecorder** is recommended.

为获得更好的录制体验，推荐使用枫笛 Saramonic 自主研发应用软件 **SmartRecorder**。



Scan the QR code and follow us!  
扫描微信关注枫笛公众号!

Shenzhen Jiayz Photo Industrial., Ltd  
深圳市长丰影像器材有限公司

A16 Building, Intelligent Terminal Industrial Park of Silicon Valley  
Power, Guanlan, Longhua District, Shenzhen, China  
深圳市龙华区观澜街道大富工业区硅谷动力智能终端产业园A16栋

☎ 400-613-1096    🌐 [www.saramonic.com](http://www.saramonic.com)    ✉ [info@saramonic.com](mailto:info@saramonic.com)